

EN

Supply-control system of electric heaters

Operation and Maintenance Manual

VENTUS

DTR-HE-ver. 3.5 (07.2019)

The logo consists of the letters 'EN' in a white, bold, sans-serif font, centered within a dark gray oval shape.

EN

The control gear complies with European Standard

IEC/EN 60439-1 + AC Standard Switchboards and low-voltage control gears

www.vtsgroup.com



Table of Contents

I. User's manual	2
1. Description of controls	2
1.1. Supply-control system	2
1.2. Main Power Switch	2
1.3. Control module	2
1.4. List of available parameters	2
2. Technical specification	3
2.1. Construction	3
2.2. Operation parameters	3
2.3. Parameters of HE control module	3
3. Operation	4
3.1 Working with display and keyboard	4
3.2 Basics of control	4
II. Advanced instructions	5
4. Details of control module's functions	5
4.1. Description of parameters	5
4.2 Alarm output	7
5. Description of control system's elements	8
5.1 Connecting signal and control elements	8
5.2. Connecting power supply	8
5.3. Required Conductors	9
6. Electric schemes	9

EN

VTS reserves the right to implement changes without prior notice

I. User's manual

1. Description of controls

1.1. Supply-control system

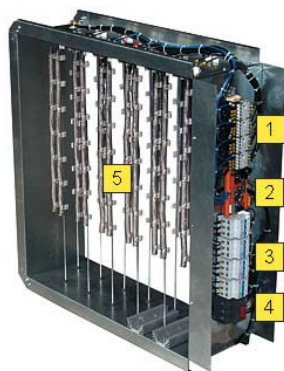

Application:

Power supply, protection and smooth power control of multistage electric heaters with rated supply voltage: 3x400V / 50Hz

Range of operation:

Electric heaters having from 1 to 6 heating levels with 18 kW each, dedicated to use in VS type Air Handling Units.

Elements:

1. Contactors
2. HE module
3. Installation switches
4. Mains switch
5. Heaters

1.2. Main Power Switch

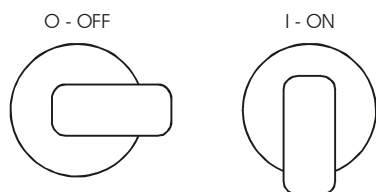

Function:
Switching on the heater.

1.3. Control module

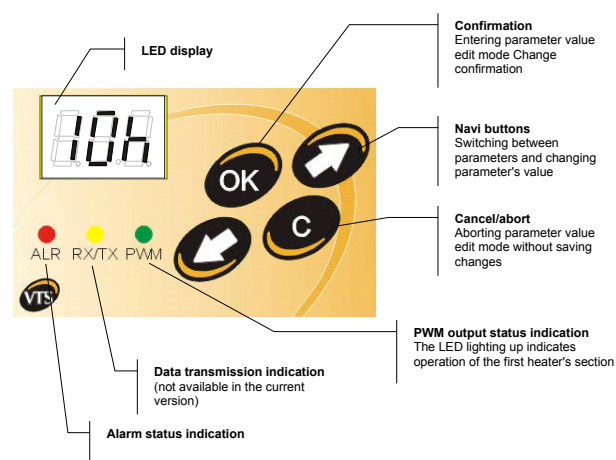

1.4. List of available parameters

Parameter	Function	Range	Factory setting	Type
10h	Upper signal limit at analog input	0.0 – 10.0V	10.0	Write and read
11h	Lower signal limit at analog input	0.0 – 10.0V	0.2	Write and read
12h	Signal value at analog input (control one)	0.0 – 10.0V	-	Read
13h	Number of available heating levels	1-6	2	Write and read
14h	PWM output range	1.0 – 10.0s	10.0	Write and read
15h	PWM output limit	0 -100%	-	Write and read
16h	Digital inputs		-	Read
17h	Digital outputs		-	Read
18h	Current percentage value of PWM output setting	0.0 – 100%	-	Read
19h	Heater operation mode selection	0-100	0	Recording and read out

VTS reserves the right to implement changes without prior notice

2. Technical specification

2.1. Construction

The control panel is built in a side wall of the electric heater

Type series of supply-control systems power [kW]	18	36	54	72	90	108
3-phase short circuit protection	1xB32	2xB32	3xB32	4xB32	5xB32	6xB32
3-phase contactors	1	2	3	4	5	6
HE control module	1					
overheating thermostat	2	2	2	2	2	2
mains switch	1*	1				

*) the switch cross-assembled on the feeding cable outside the heater's casing

2.2. Operation parameters

system	TN
U_3 rated power supply voltage	3x400 V
U_i rated insulation voltage	400 V
U_{imp} rated impulse withstand voltage	2.5 kV
rated short-time withstand current I_{cw} for respective circuits - effective value of alternating-current component withstood during 1 s i.e.: short-circuit current expected at connecting voltage of	6 kA
rated peak withstand current (i_{pk}) at $\cos\Phi=0,5$	10.2 kA
rated short-circuit current	6 kA
coincidence factor	0.8
rated frequency	50 Hz \pm 1Hz
protection class	IP00
acceptable operating temperature	0 x 50°C
supply voltage of control circuits	24 V AC
EMC environment	1

2.3. Parameters of HE control module

Supply voltage	24 VAC
Digital output ("Open collector")	Amount: 6 pcs Voltage: 24 VDC Prąd max: 0,5A
PWM output ("Open collector")	Amount: 1 pcs Voltage: 24 VDC
Digital inputs	Amount: 3 pcs Voltage: 24VDC
Alarm output	3-pole relay

CAUTION!



1. Connection and start-up of the heater should be done by qualified staff only.
2. The control system is designed for use with the VTS heaters built-in the VTS AHUs only.

3. Operation

CAUTION!



Start-up of the heater is strictly blocked by the overheating thermostat and the signal of the fan's pressure control unit.

3.1 Working with display and keyboard

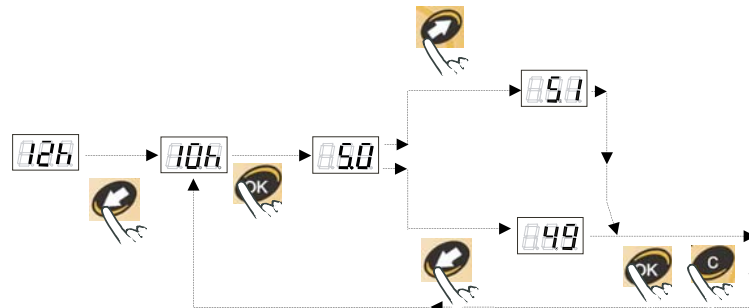

3.2 Basics of control

Power output of the heater is controlled by the PWM signal (Pulse Width Modulation), through alternate switching on and off the first heating level equipped with solid-state relays (SSR). Depending on chosen mode of operation, duration of the switch-on phase is directly proportional to the control signal supplied to the analog input, or for time of activation of digital input DI3. Next heating levels are switched on by the contactors when the first heating level reaches the max power output. Once the successive heater's level is switched on, the power of the first one goes down to the min value.

Heater operation mode (19h=0)

The heaters' operational voltage is supplied only then, if all three 2-state inputs of the HE control module signal high level. Even if one of the inputs signals a low level, the control module enters the alarm state till all signals at the 2-state inputs are present. The alarms do not require manual cancellation.

Initial heater operation mode (19h=1...100)

Operating voltage of heaters can only be supplied when the DI1 and DI2 switching inputs of the HE control module indicate high state. If at least one of the inputs indicates low state the control module switches the heater off and in the case the DI2 input indicates low state it goes into an alarm state. DI3 is the control input. If it is active the module increases the heater's power and if it is not active the heater's power decreases. The rate of increasing and decreasing the heater's power is set in 19h parameter in 1-100% range of full heater's power per minute [%/min]

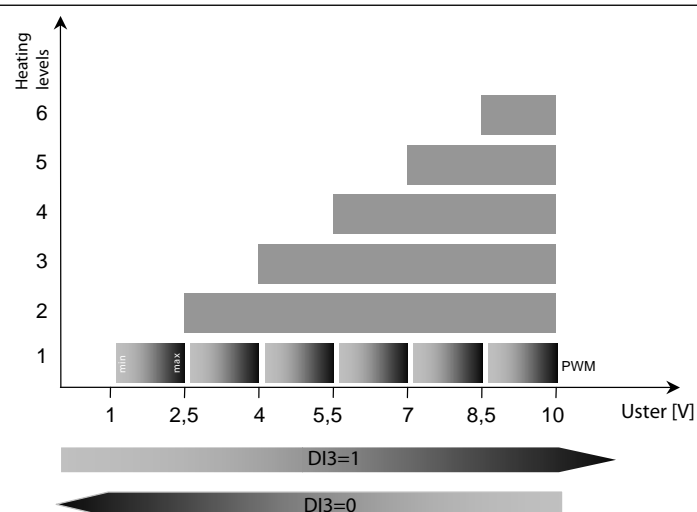

VTS reserves the right to implement changes without prior notice

II. Advanced instructions

4. Details of control module's functions

4.1. Description of parameters

19h	Heater operation mode selection
<p>Range: 0 – 100.read / write possible</p> <p>The parameter determines the heater operation algorithm. 0 – operation in the typical electric heater mode. The heater's power is proportional to the signal on the analogue input, digital inputs play security functions.</p> <p>1-100 – operation in the initial heater mode. The heater's power increases or decreases smoothly depending on the state of DL3 digital input. The analogue input remains inactive. DI1 and DI2 digital inputs play security functions.</p> <p>EXAMPLE: the heater's power 35kW, 19h parameter=5, depending on the state of the heater and DI3 input, the heater's power will increase or decrease smoothly at the speed of 1.8kW per minute.</p>	
10h	Upper signal limit at analog input
<p>Range: 0.0-10.0V Record and read options are available. Default value: 10</p> <p>The parameter defines a value of the control signal, at which the control module sets the max power output of the heater.</p> <p>CAUTION! The max power output depends on the 13h and 15h parameters.</p>	
11h	Lower signal limit at analog input
<p>Range: 0.0-10.0V Record and read options are available. Default value: 0.2</p> <p>The parameter defines a value of the control signal, at which the control module switches on the first heating level and set the min power output of the heater. This value should be higher than zero. Some voltage may induce in the control cable due to interference of other electric devices (noises). Setting too low value of the 11h parameter may result in an unintended switch-on of the electric heater.</p>	
12h	Signal value at analog input (control one)
<p>Range: 0.0-10.0V Only reading option is available</p> <p>The parameter contains some information on current signal value at the analog input (control one). The parameter has got an informational function and is designed mainly for checking the system.</p> <p>EXAMPLE If, against expectations, the heater does not work and no alarm message is displayed, please check the 12h parameter value. If this value is lower than the value provided in the 12h parameter, it means that there has been no condition to switch the heater on.</p>	

EN

VTS reserves the right to implement changes without prior notice

13h	Number of available heating levels																			
<p><u>Range: 1-6. Record and read options are available. Default value: 2</u></p> <p>The parameter defines the max available number of heating levels. Thanks to this parameter the max output power of the heater can be limited by the level listed below.</p> <table border="1" style="width: 100%; border-collapse: collapse; margin-top: 10px;"> <thead> <tr> <th style="width: 30%;">Number of available heating levels</th> <th>1</th> <th>2</th> <th>3</th> <th>4</th> <th>5</th> <th>6</th> </tr> </thead> <tbody> <tr> <td>Max output [kW]</td> <td>18</td> <td>36</td> <td>54</td> <td>72</td> <td>90</td> <td>108</td> </tr> </tbody> </table> <p>EXAMPLE 1. Number of heating levels for the power consumption at $P_n = 6.7kW$.</p> $13h = \frac{P_n}{P_{max}} = \frac{6,7kW}{18kW} \approx 0,37$ <p style="margin-left: 300px;">The chosen number of heating levels is 1.</p> <p>EXAMPLE 2. Number of heating levels for the power consumption at $P_n=100 kW$.</p> $13h = \frac{P_n}{P_{max}} = \frac{100kW}{18kW} \approx 5,56$ <p style="margin-left: 300px;">The chosen number of heating levels is 6.</p> <p>P_{max} - max output of the heater's first level</p> <p>CAUTION! The max power output of the whole heater depends also on the 15h parameter.</p>							Number of available heating levels	1	2	3	4	5	6	Max output [kW]	18	36	54	72	90	108
Number of available heating levels	1	2	3	4	5	6														
Max output [kW]	18	36	54	72	90	108														

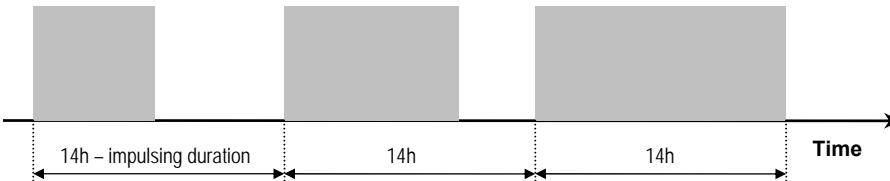
14h	PWM output range					
<p><u>Range: 1.0-10.0s Record and read options are available. Default value: 10.0</u></p> <p>The parameter defines the full cycle duration of the impulse width. The full cycle consists of the switch-on time of first level of heating (grey rectangle) and of the time when the first level of heating is switched off.</p> <div style="margin-top: 10px;"> <p style="display: flex; justify-content: space-around;"> Average output: 50% Average output: 75% Average output: 100% </p>  <p style="margin-top: 10px;">The diagram shows three grey rectangles on a horizontal axis labeled 'Time'. The first rectangle is labeled 'Average output: 50%' and has a width of '14h - impulsing duration'. The second rectangle is labeled 'Average output: 75%' and has a width of '14h'. The third rectangle is labeled 'Average output: 100%' and has a width of '14h'. Vertical dashed lines mark the boundaries of each cycle.</p> </div> <p>Extension of the impulsing time is recommended if the max heater output power is defined below 18kW and also when the heater power consumption causes interferences of other electric devices, e.g.: lighting flickering..</p> <p>Shortening of impulsing time is recommended in order to improve the control accuracy, i.e.: when first heating level impulsing causes periodic fluctuation of supply-air temperature measurement of a heated room.</p>						

VTS reserves the right to implement changes without prior notice

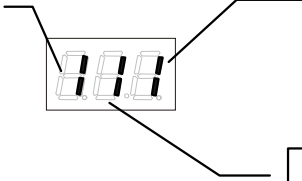
15h	PWM output limit		
<p><u>Range: 0-100%. Record and read options are available. Default value: 100%</u> The parameter defines, in a percentage value, the max output power in which the first heating level with smooth power control is able to work. Its value should be determined basing on power consumption defined in the ventilation system design.</p> <p>EXAMPLE 1. POWER consumption: Pn=6.7kW</p> $15h = \left[\frac{Pn}{18kW} + 1 - [13h] \right] \cdot 100\% = \left[\frac{6,7kW}{18kW} + 1 - 1 \right] \cdot 100\% \approx 37\%$ <p>EXAMPLE 1. . POWER consumption Pn=100 kW</p> $15h = \left[\frac{Pn}{18kW} + 1 - [13h] \right] \cdot 100\% = \left[\frac{100kW}{18kW} + 1 - 6 \right] \cdot 100\% \approx 55\%$ <p>Pmax - max output of the heater's first level</p>			
16h	Digital input (2-state)		
<p><u>Range: 000-111 (binary value). Only reading option available.</u> The parameter contains information on status of three available 2-state inputs. 0 indicates lack of input signal, 1 indicates that the 24VDC signal is present.</p> <div style="display: flex; justify-content: space-around; align-items: center;"> <div style="border: 1px solid black; padding: 5px; width: 20%;"> <p>DI.1 FAN'S PRESSURE CONTROL UNIT It protects the heater against operation without air-flow.</p> </div>  <div style="border: 1px solid black; padding: 5px; width: 20%;"> <p>DI.3 EXTERNAL ELEMENT User's element or device allowing to stop operation of the heater.</p> </div> <div style="border: 1px solid black; padding: 5px; width: 20%;"> <p>DI.2 OVERHEATING THERMOSTAT Protects the heater against overheating</p> </div> </div>			
17h	Digital output (2-state)		
<p>The parameter contains information on six available digital outputs designed for switching on next contactors, through which the next heater's levels are fed.</p> <table style="width: 100%; border-collapse: collapse;"> <tr> <td style="width: 50%; vertical-align: top;"> <div style="display: flex; flex-direction: column; gap: 10px;"> <div style="display: flex; align-items: center;"> <p>DO.1 – first heating level Heater power output: 0 - 18kW</p> </div> <div style="display: flex; align-items: center;"> <p>DO.2 – second heating level Heater power output: 18 - 36kW</p> </div> <div style="display: flex; align-items: center;"> <p>DO.3 – third heating level Heater power output: 36 - 54kW</p> </div> </div> </td> <td style="width: 50%; vertical-align: top;"> <div style="display: flex; flex-direction: column; gap: 10px;"> <div style="display: flex; align-items: center;"> <p>DO.4 – fourth heating level Heater power output: 54 - 72kW</p> </div> <div style="display: flex; align-items: center;"> <p>DO.5 – fifth heating level Heater power output: 72 - 90kW</p> </div> <div style="display: flex; align-items: center;"> <p>DO.6 – sixth heating level Heater power output: 90 - 108 kW</p> </div> </div> </td> </tr> </table> <p>CAUTION! The parameter does not contain info on the status of alarm output.</p>		<div style="display: flex; flex-direction: column; gap: 10px;"> <div style="display: flex; align-items: center;"> <p>DO.1 – first heating level Heater power output: 0 - 18kW</p> </div> <div style="display: flex; align-items: center;"> <p>DO.2 – second heating level Heater power output: 18 - 36kW</p> </div> <div style="display: flex; align-items: center;"> <p>DO.3 – third heating level Heater power output: 36 - 54kW</p> </div> </div>	<div style="display: flex; flex-direction: column; gap: 10px;"> <div style="display: flex; align-items: center;"> <p>DO.4 – fourth heating level Heater power output: 54 - 72kW</p> </div> <div style="display: flex; align-items: center;"> <p>DO.5 – fifth heating level Heater power output: 72 - 90kW</p> </div> <div style="display: flex; align-items: center;"> <p>DO.6 – sixth heating level Heater power output: 90 - 108 kW</p> </div> </div>
<div style="display: flex; flex-direction: column; gap: 10px;"> <div style="display: flex; align-items: center;"> <p>DO.1 – first heating level Heater power output: 0 - 18kW</p> </div> <div style="display: flex; align-items: center;"> <p>DO.2 – second heating level Heater power output: 18 - 36kW</p> </div> <div style="display: flex; align-items: center;"> <p>DO.3 – third heating level Heater power output: 36 - 54kW</p> </div> </div>	<div style="display: flex; flex-direction: column; gap: 10px;"> <div style="display: flex; align-items: center;"> <p>DO.4 – fourth heating level Heater power output: 54 - 72kW</p> </div> <div style="display: flex; align-items: center;"> <p>DO.5 – fifth heating level Heater power output: 72 - 90kW</p> </div> <div style="display: flex; align-items: center;"> <p>DO.6 – sixth heating level Heater power output: 90 - 108 kW</p> </div> </div>		
18h	Current percentage value of PWM output setting		
<p><u>Range: 0-100%. Only reading option available.</u> The parameter defines information on a percentage value of the set PWM output. The information should be consider as a percentage value of the max power output of the first heating level (in standard VTS 18kW heater</p>			

VTS reserves the right to implement changes without prior notice

4.2 Alarm output

The moment an alarm state is raised all heating stages are switched off, the PWM signal is zero, the three-pole alarm transmitter contact is switched. Alarm state is indicated on the display with the symbol presented below.



Heater operation mode (19h=0)



It is caused by disappearance of at least one digital input whose current state is displayed under the 16h parameter. The alarm state is automatically deactivated when three signals on digital inputs appear.

Initial heater operation mode (19h=1...100)

It is caused by disappearance of signal on DI2 input only. The alarm state is automatically deactivated when signal on DI2 input appears.

ATTENTION: If the state of DI2 input changes three times within an hour the system is blocked and it needs manual restart by switching the module off and on again or by setting the 19h parameter to 0 and then setting it back to a value from the 1-100 range.

5. Description of control system's elements

Element	Functions and application	Construction	Operation parameters
 OVERHEATING THERMOSTAT	<ul style="list-style-type: none"> - Protection module of the electric heater protecting it against overheating 	<ul style="list-style-type: none"> - Metal casing - Two screw terminals - bimetallic element with a function of a normally-closed contact 	<ul style="list-style-type: none"> - activation temperature: 65±3°C - hysteresis: 17±3°C - parameters of bimetallic element - voltage: 30VDC - permissible load A
 DIFFERENTIAL PRESSURE CONTROL	<ul style="list-style-type: none"> - Fan's pile-up control 	<ul style="list-style-type: none"> - Membrane coupled with mechanical module. If the acceptable pressures difference is exceeded, the membrane undergoes deformation and switches off - casing: plastic 	<ul style="list-style-type: none"> - measurement: 20 – 300 Pa: - rated operational voltage 30VDC - output signal: voltage-free (switching contact) - number of cycles: <math>10^6</math> cycles - operation conditions: -30 – +85°C - protection class: IP44 <p>Recommended pressure control operating position: horizontal. In case of vertical alignment, the set point value is 11 Pa higher than the real one.</p>
 THERMOSTAT	<ul style="list-style-type: none"> - Controlling the electric heater operation in the initial heater mode 	<ul style="list-style-type: none"> - Measuring element: appropriate capillary 2 or 6m long filled with fast-boiling agent, - thermostat equipped with adjusting screws enabling change of limiting temperature and system reconnection temperature (hysteresis) 	<ul style="list-style-type: none"> - Measurement: -18 – +15°C, - hysteresis value: 1.7 – 12°C, - operation rated voltage: 30V, DC or 230 VAC, - output signal: no voltage (switchable contact), - protection class: IP44

VTS reserves the right to implement changes without prior notice

5.1 Connecting signal and control elements

No.	Location of cable connection	Diagram ref no.	Conductor type	Cross-section [mm ²]
1.	Control signal input	21	[1]	1x1
2.	Feeding of HE control module	11, 12		2x1
3.	Digital inputs	17, 18, 19		3x1
4.	Alarm output	22, 23, 24		1x1 lub 2x1

5.2. Connecting power supply

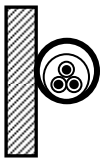

The system feeding cable should be connected in accordance with the electric diagram. The wire cross-sections has been selected for long-term current capacity according to the Picture, for three load conductors. Due to the protection selectivity, length, cable placement method and short-circuit currents, revise the feeders' cross-sections in the table below.

No.	HEATER'S POWER OUTPUT	DATA OF PROTECTION ELEMENT	RATED CURRENT	SYSTEM FEEDING CABLE TYPE [2]
	kW	3x400V/50Hz	L1 = L2 = L3 [A]	[mm ²]
1.	18	1xB32	27	4x16
2.	36	2xB32	54	4x25
3.	54	3xB32	81	4x35
4.	72	4xB32	108	4x70
5.	90	5xB32	135	4x95
6.	108	6xB32	162	4x95
7.	216	6xB63	322	2x 4x95

5.3. Required Conductors

	Figure	Description	Parameters
[1]		Control cables, single- or multi-conductor, PCV insulated	Rated voltage: 300/500 V Operating temperature: -40 up to 70°C
[2]		Multi-conductor cables, with single- or multi-wire copper conductors, PCV insulated. In case of conductor's cross-section exceeding 25 mm ² it is recommended to use multi-conductor cable in jacket (flexible)	Rated voltage: 450/750V Operating temperature: -40 up to 70°C

VTS reserves the right to implement changes without prior notice

6. Electric schemes

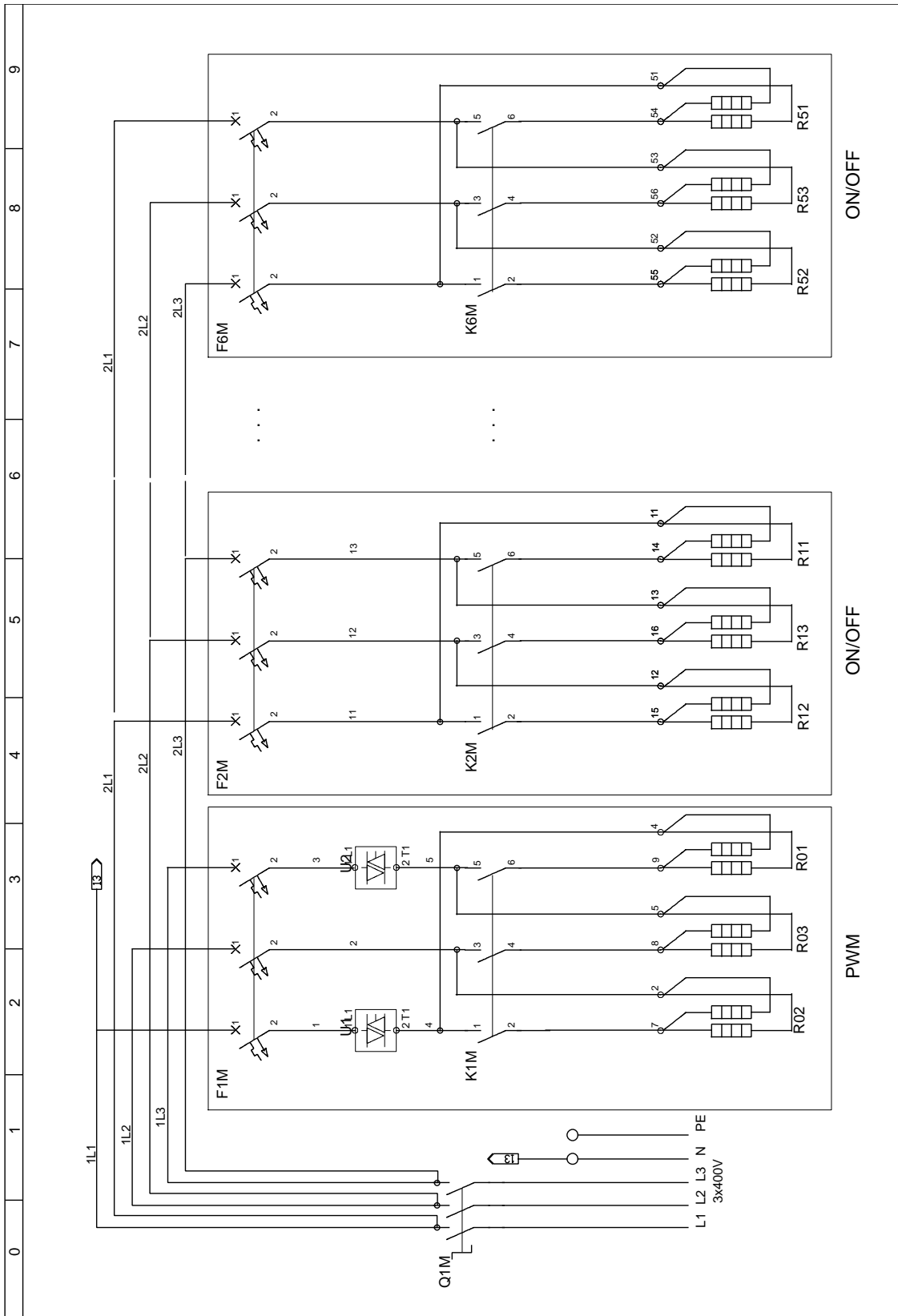

VTS reserves the right to implement changes without prior notice

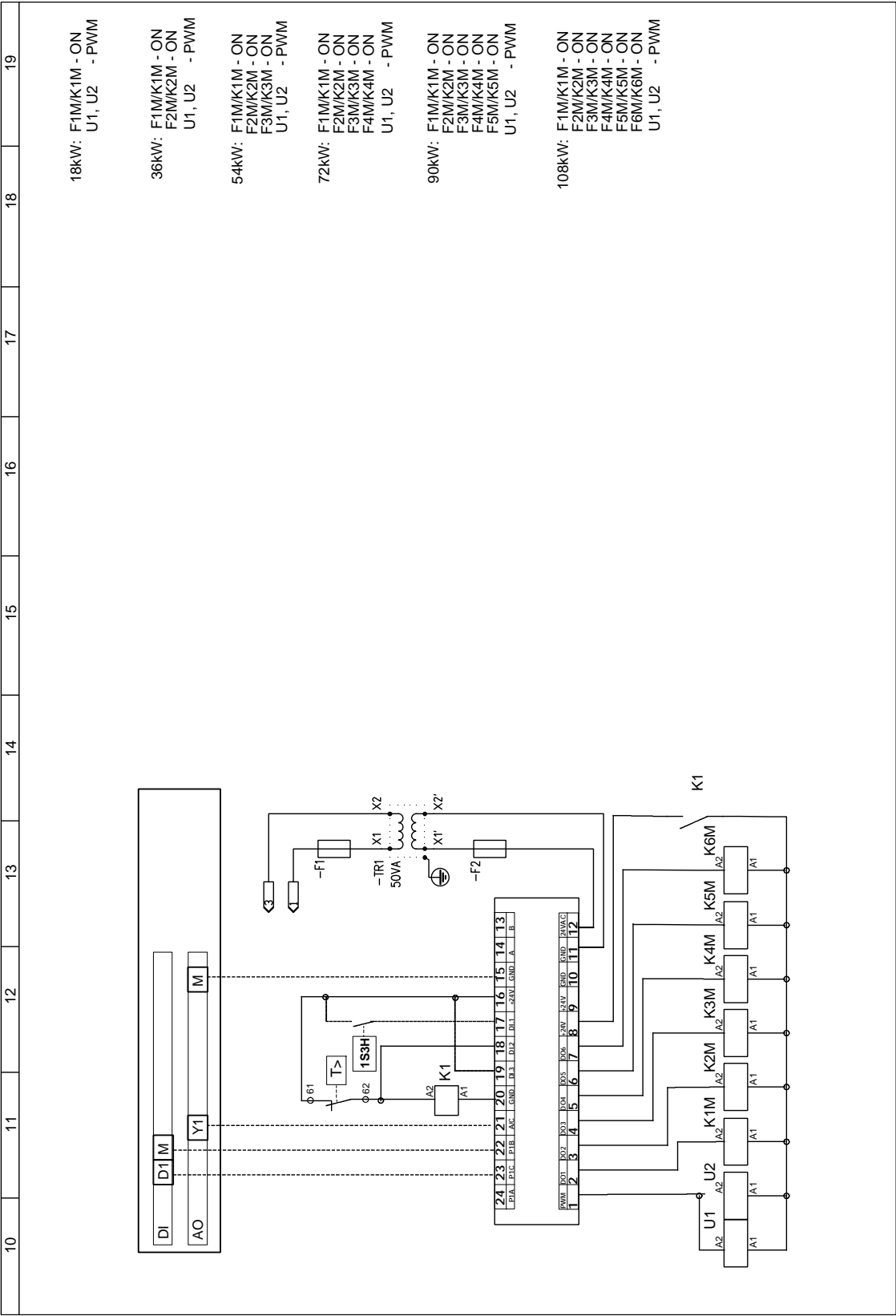

18kW: F1M/K1M - ON
U1, U2 - PWM

36kW: F1M/K1M - ON
F2M/K2M - ON
U1, U2 - PWM

54kW: F1M/K1M - ON
F2M/K2M - ON
F3M/K3M - ON
U1, U2 - PWM

72kW: F1M/K1M - ON
F2M/K2M - ON
F3M/K3M - ON
F4M/K4M - ON
U1, U2 - PWM

90kW: F1M/K1M - ON
F2M/K2M - ON
F3M/K3M - ON
F4M/K4M - ON
F5M/K5M - ON
U1, U2 - PWM

108kW: F1M/K1M - ON
F2M/K2M - ON
F3M/K3M - ON
F4M/K4M - ON
F5M/K5M - ON
F6M/K6M - ON
U1, U2 - PWM

VTS reserves the right to implement changes without prior notice